

# 20 CHESTNUT STREET

## BOSTON, MASSACHUSETTS

### EXTERIOR STAIR

Schedule of Drawings

MARCH 21, 2024



**PROJECT SUMMARY:**

-NEW EXTERIOR METAL STAIR (REPLACE EXISTING WOOD STAIR)

Sht. No.	Title
T000	TITLE SHEET
A1.00	PHOTOGRAPHS
A1.01	EXISTING EXTERIOR WOOD STAIR PLAN
A1.02	PROPOSED EXTERIOR METAL STAIR PLAN
A3.00	EXISTING AND PROPOSED ELEVATIONS

**LOCATION MAP:**

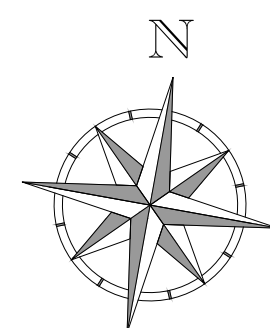
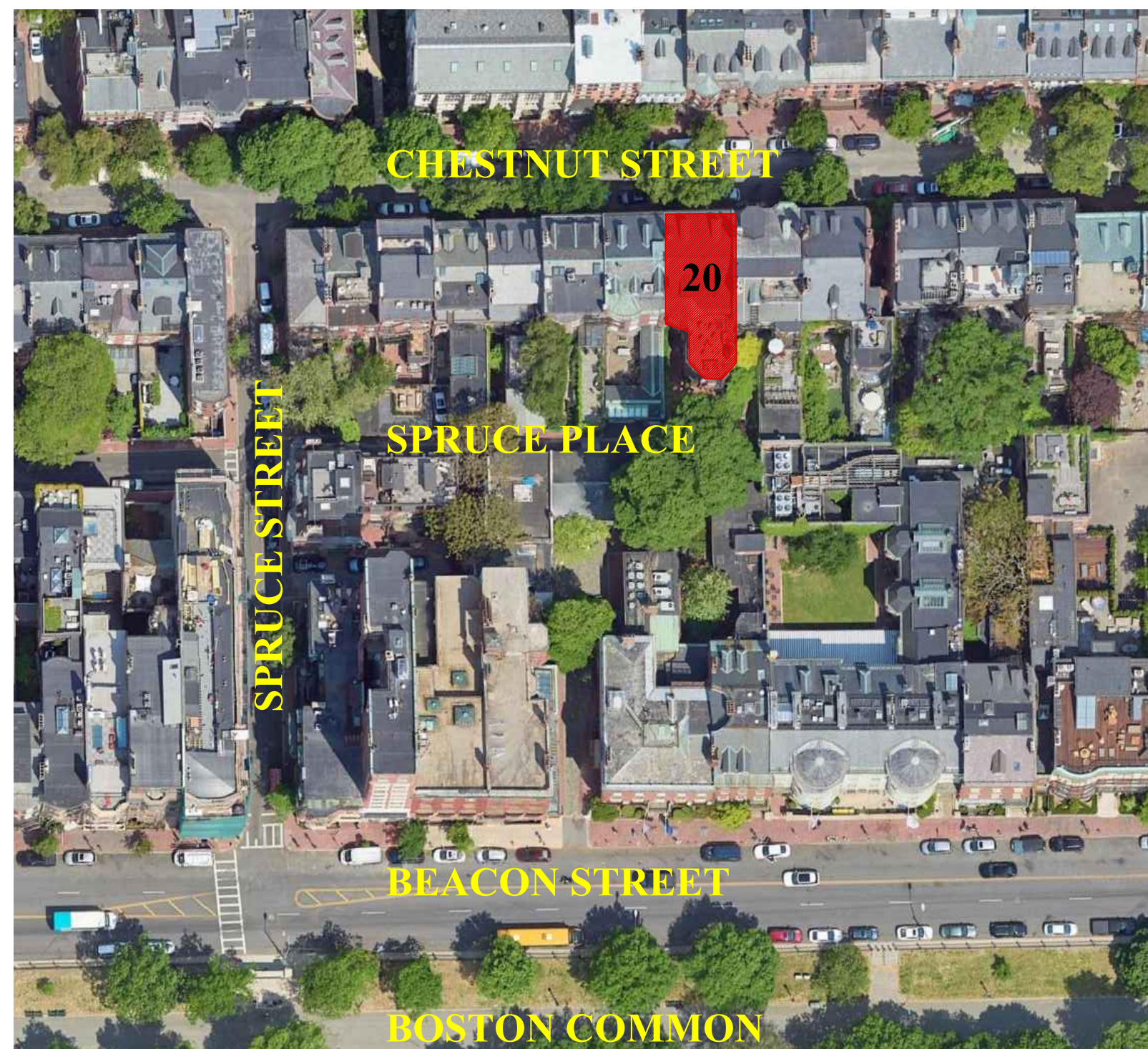



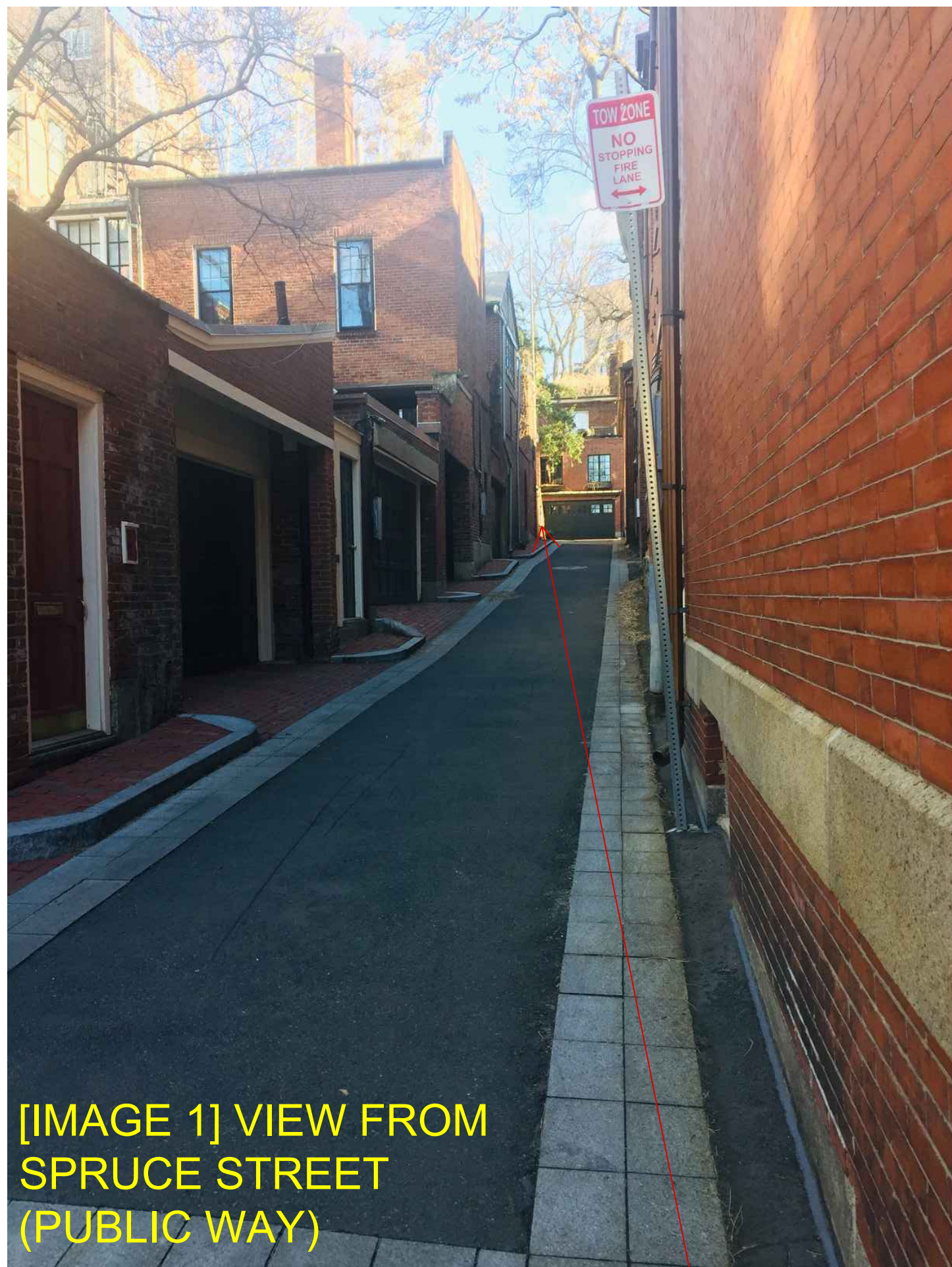

[[IMAGE 1]] VIEW FROM  
SPRUCE STREET  
(PUBLIC WAY)

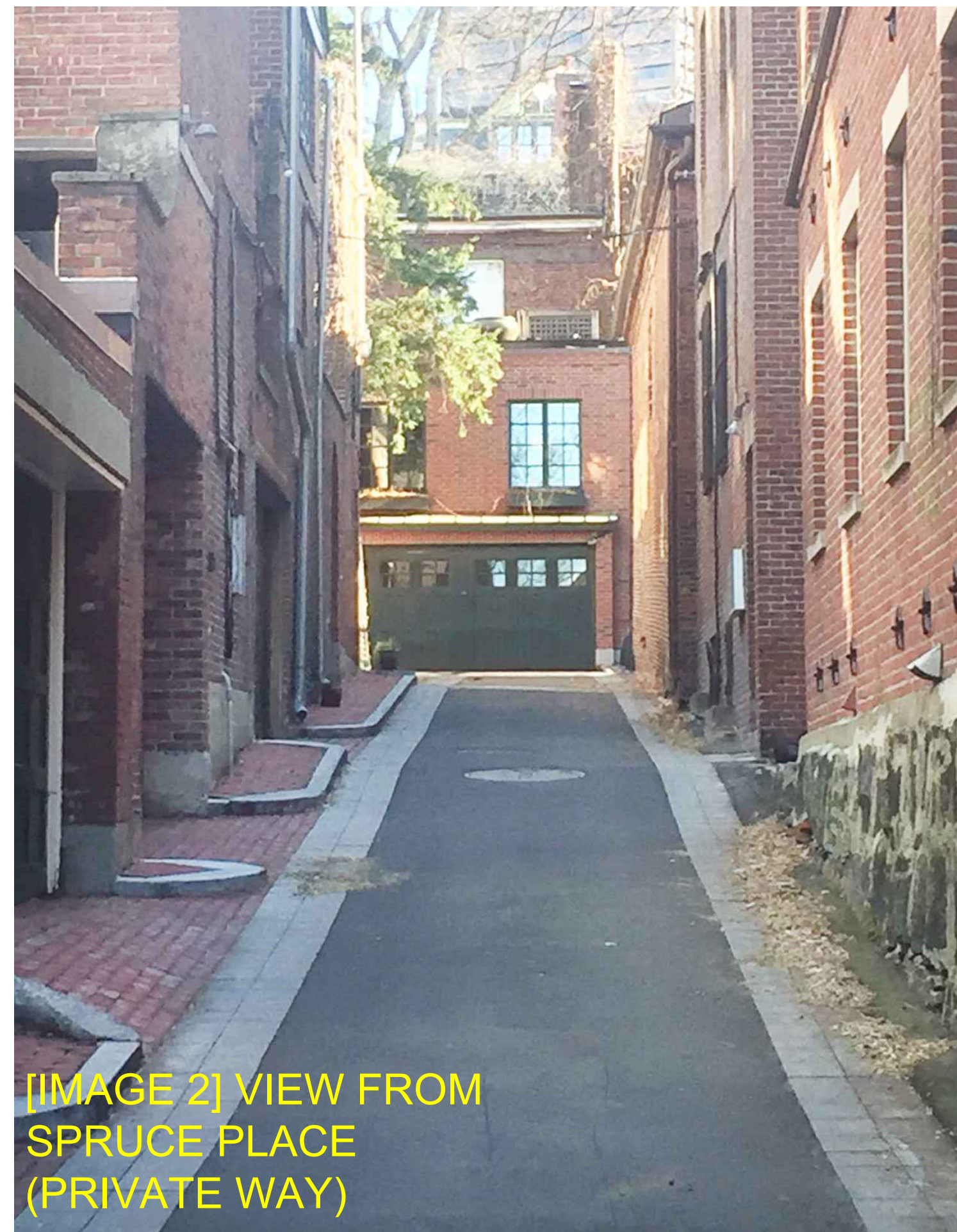

[[IMAGE 2]] VIEW FROM  
SPRUCE PLACE  
(PRIVATE WAY)



[[IMAGE 3]] VIEW FROM  
SPRUCE PLACE  
(PRIVATE WAY)



[[IMAGE 4]] VIEW FROM  
SPRUCE PLACE  
(PRIVATE WAY)

PROPOSED STAIR AROUND CORNER  
(MARGINALLY VISIBLE FROM PUBLIC WAY)



[[IMAGE 5]] OLDER VIEW FROM  
SPRUCE PLACE  
(PRIVATE WAY)



[[IMAGE 6]] VIEW FROM  
SPRUCE PLACE  
(PRIVATE WAY)

PHOTOGRAPHS

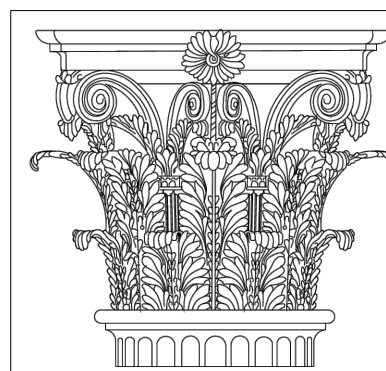

PAULI & URIBE  
ARCHITECTS LLC  
Classic Architecture  
Interior Design  
121 Mount Vernon Street  
Boston, Massachusetts, 02108  
617 227 0954 • www.pauli-uribe.com

20 CHESTNUT STREET  
BOSTON, MA 02108

SHEET TITLE:  
EXISTING EXTERIOR  
WOOD STAIR PLAN  
DATE: MARCH 21, 2024  
SCALE: AS NOTED  
DRAWN: JM & RJP  
CHECKED: JGUR & MZP

SHEET NO.

A1.00



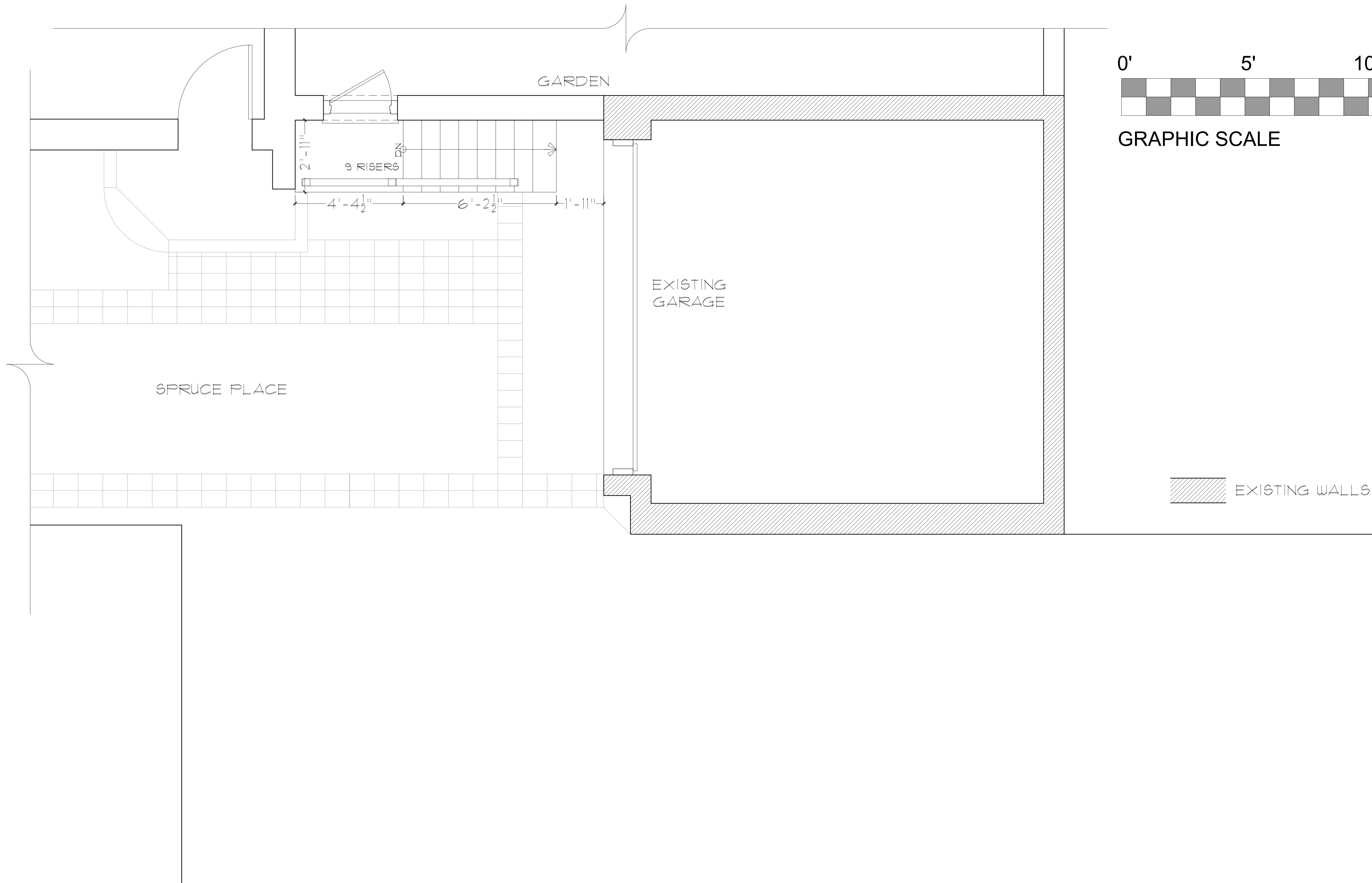

EXISTING EXTERIOR WOOD STAIR PLAN

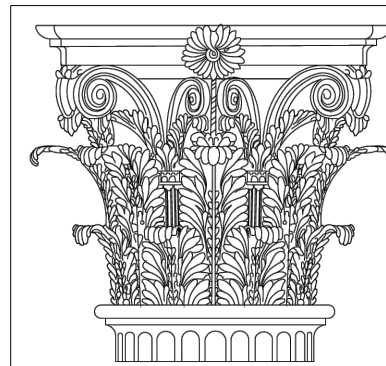
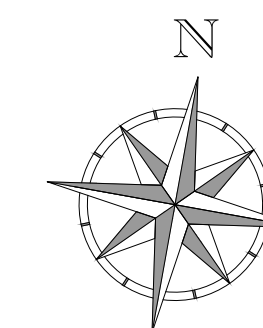

**PAULI & URIBE**  
**ARCHITECTS LLC**  
 Classic Architecture  
 Interior Design  
 121 Mount Vernon Street  
 Boston, Massachusetts, 02108  
 617 227 0954 • www.pauli-uribe.com

**20 CHESTNUT STREET**  
 BOSTON, MA 02108

**SHEET TITLE:**  
 EXISTING EXTERIOR  
 WOOD STAIR PLAN  
**DATE:** MARCH 21, 2024  
**SCALE:** AS NOTED  
**DRAWN:** JM & RJP  
**CHECKED:** JGUR & MZP

**SHEET NO.**

A1.01

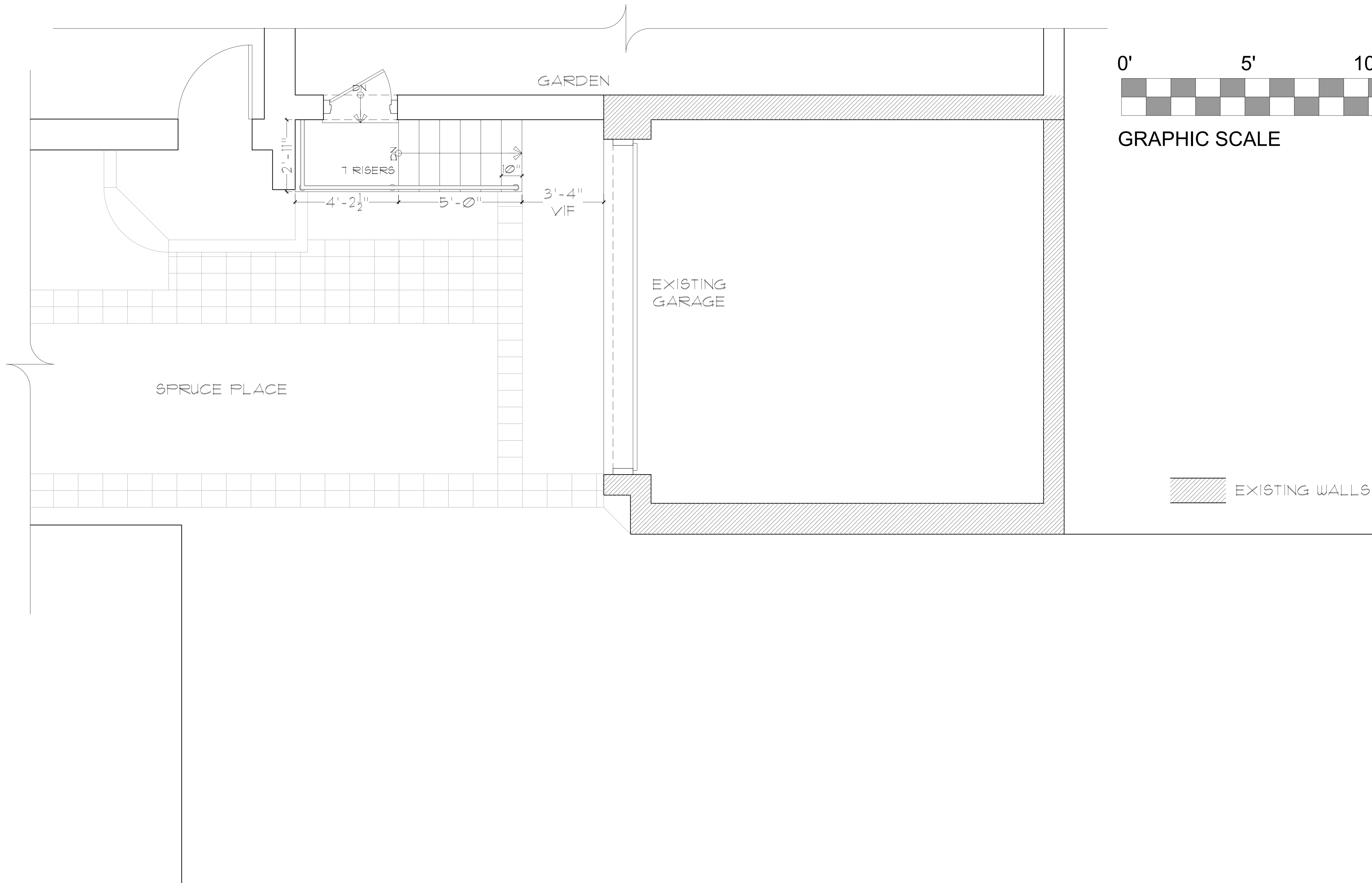

PROPOSED EXTERIOR METAL STAIR PLAN

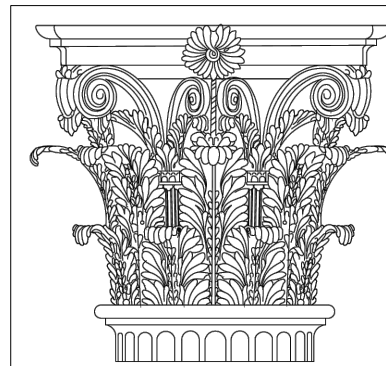
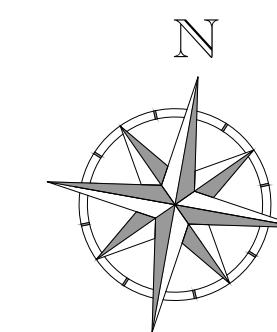

**PAULI & URIBE**  
**ARCHITECTS LLC**  
 Classic Architecture  
 Interior Design  
 121 Mount Vernon Street  
 Boston, Massachusetts, 02108  
 617 227 0954 • www.pauli-uribe.com

**20 CHESTNUT STREET**  
 BOSTON, MA 02108

SHEET TITLE:  
 PROPOSED EXTERIOR  
 METAL STAIR PLAN  
 DATE: MARCH 21, 2024  
 SCALE: AS NOTED  
 DRAWN: JM & RJP  
 CHECKED: JGUR & MZP

SHEET NO.

A1.02

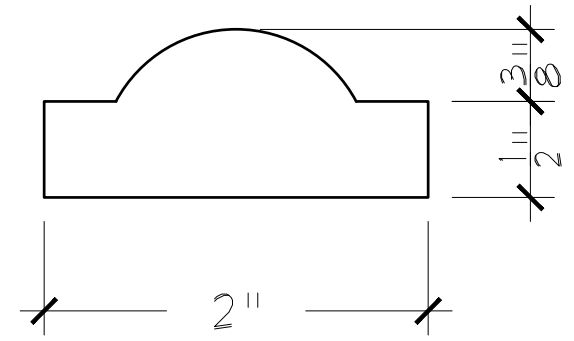

3 PROPOSED RAILING PROFILE  
 FULL: 12" = 1'-0", HALF: 6" = 1'-0"

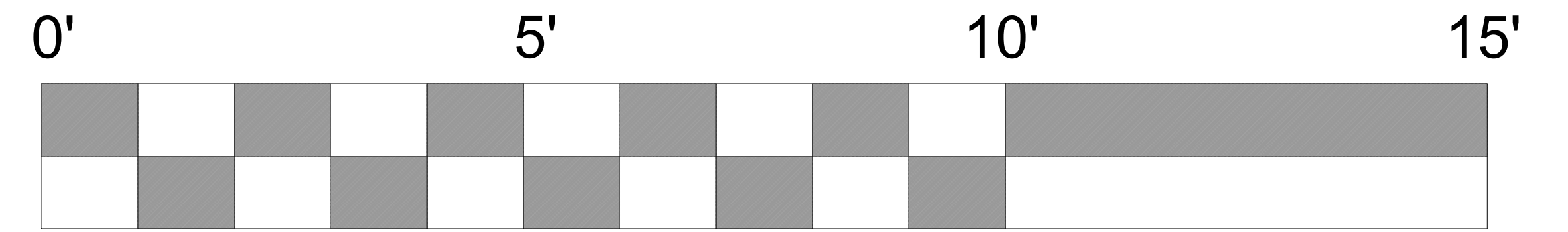

GRAPHIC SCALE

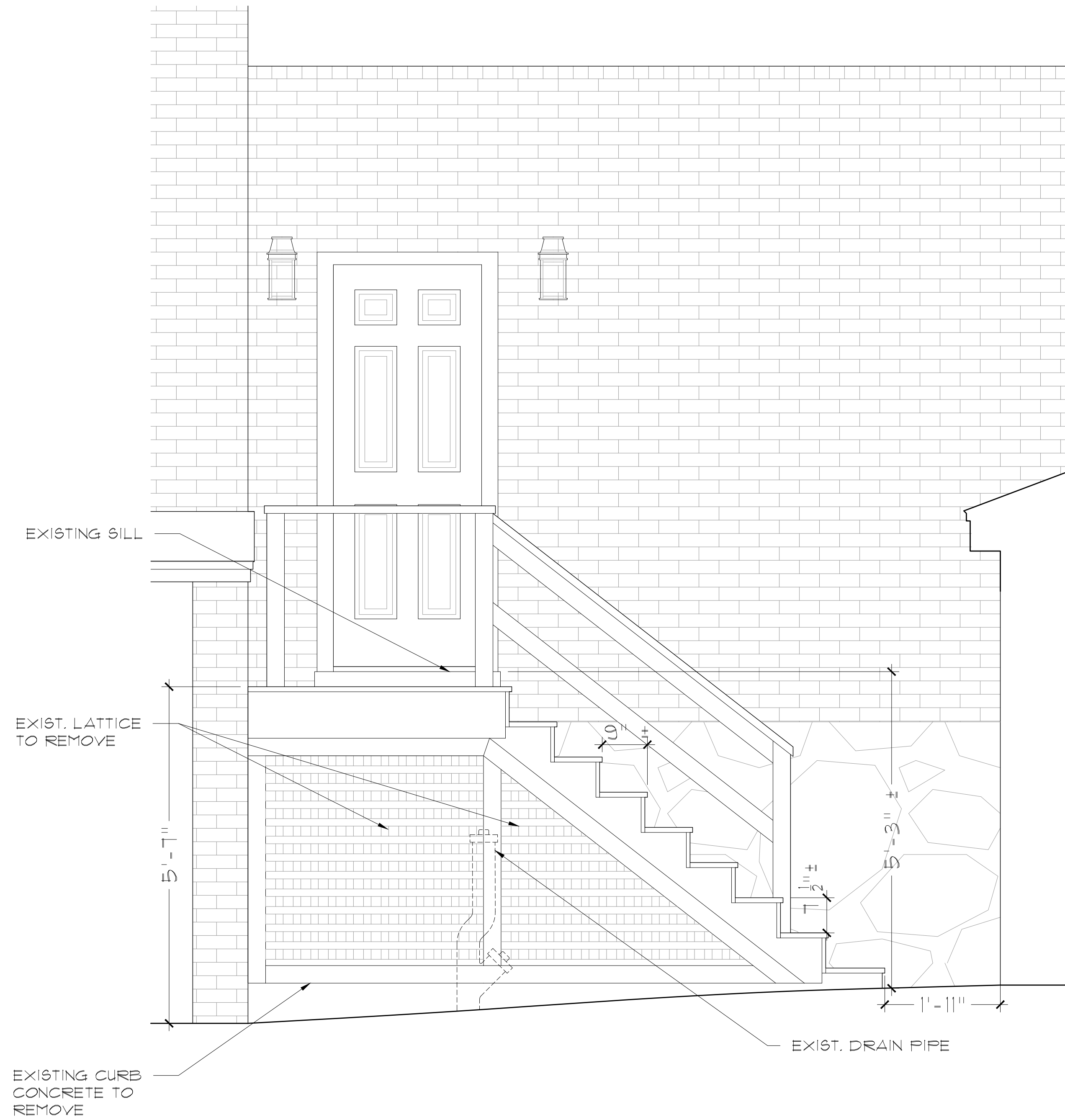

EXISTING EXTERIOR WOOD STAIR

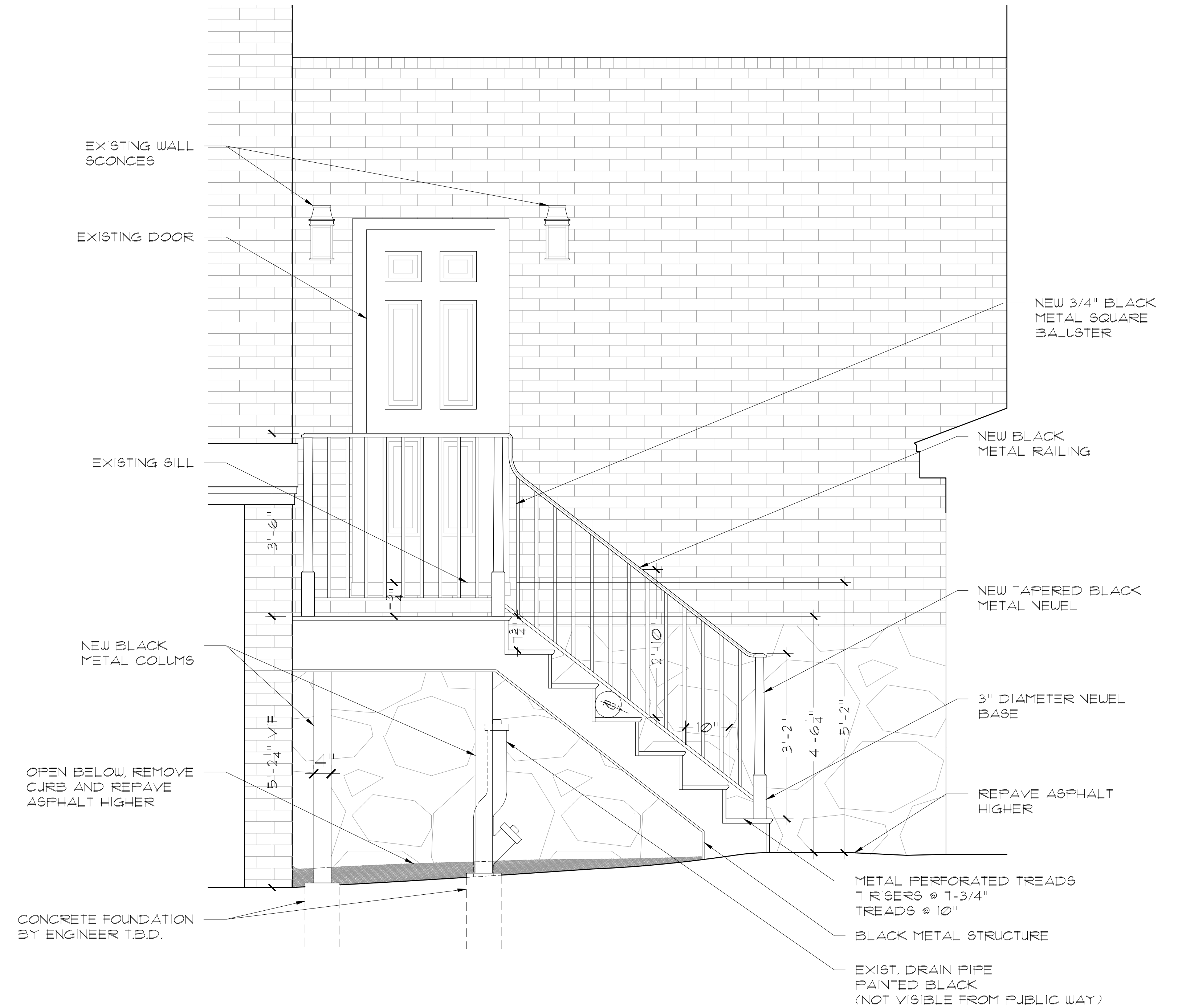

PROPOSED EXTERIOR METAL STAIR



**PAULI & URIBE**  
**ARCHITECTS LLC**  
 Classic Architecture  
 Interior Design  
 121 Mount Vernon Street  
 Boston, Massachusetts, 02108  
 617 227 0954 • www.pauli-uribe.com

20 CHESTNUT STREET  
 BOSTON, MA 02108

SHEET TITLE: EXISTING AND PROPOSED ELEVATIONS		SHEET NO. A3.00
DATE:	MARCH 21, 2024	
SCALE:	AS NOTED	
DRAWN:	JM & RJP	
CHECKED:	JGUR & MZP	